

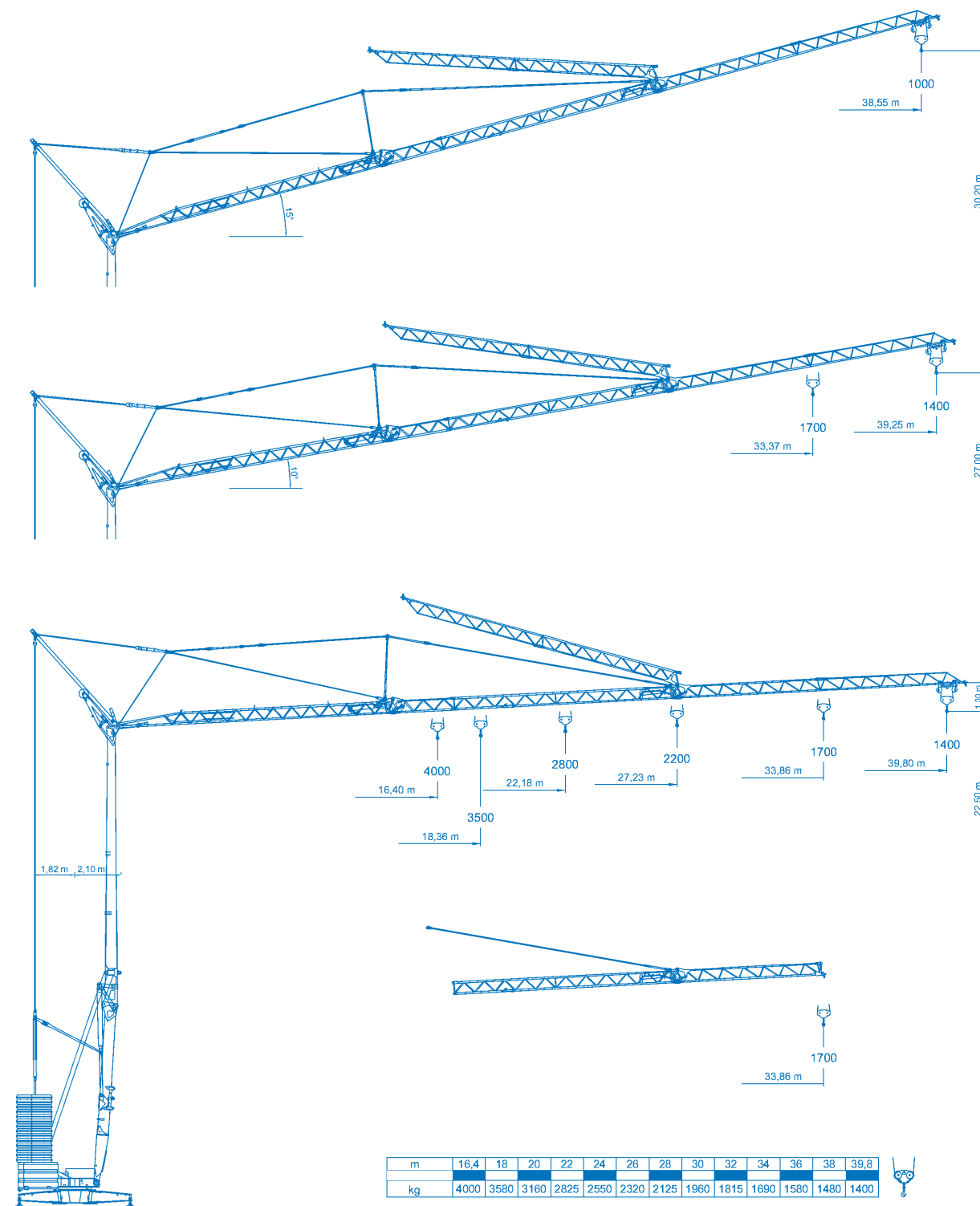





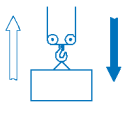
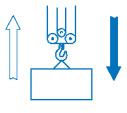

EUROGRU[®]

E 40.14

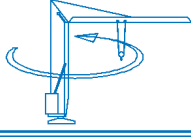
DIN / FEN / CNR 



= 		400V (±10%) 50 Hz		12kVA	
 m/l' kg kW		▶	▶▶	▶▶	
	6,5	22	45	55	
	4000	3000	1500	1200	11 (Inverter)
 m/l' kg kW		▶	▶▶	▶▶	
	-	-	-	-	
	-	-	-	-	-
 m/l' kW		▶	▶▶		
	17,8	28,6	53,5 (↗39,3)		
					3 (Inverter)
 n/l' kW		▶	▶▶		
	0,21	0,5	1,0		
					2,2 (Inverter)
 min	▶			8.100 kg + 21.000 kg	
	10 kW 3				
	8100 kg	5400 kg	2700 kg	0 kg	
P1					
P2					

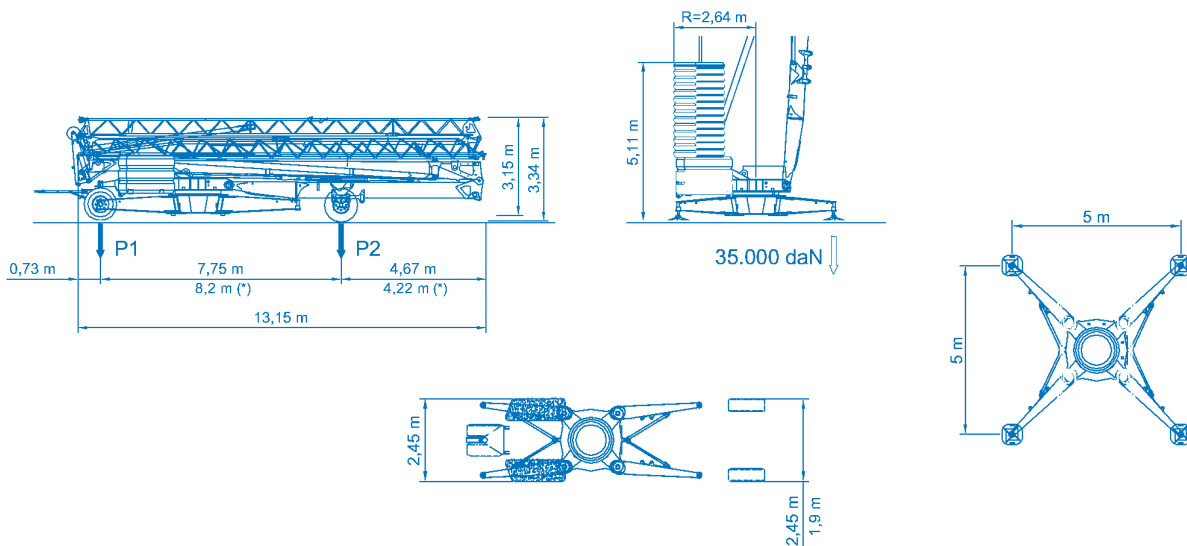

EUROGRU®

Am Dornbusch 10
64390 Erzhausen
www.eurogru.de

Telefon: +49 (0) 6150 13440
Fax: +49 (0) 6150 7002
Email: info@eurogru.de